



Índice

CASQUILHOS GRAFITADOS BOLEXP

Descrição do produto.....	2.9
Casquilho de Anel de Topo 311 Tipo Z1100W / E1115.....	2.10
Casquilho de Anel 312 Tipo Z1000W / E1105.....	2.10
Casquilho de Anel 313 Tipo Z13W / E1125.....	2.11
Casquilho de Anel de Topo 401.....	2.11
Casquilhos de Anel 402 e 403.....	2.12
Casquilho de Anel 404.....	2.13
Régua guia 405 Tipo Z1850W / E3151.....	2.13
Régua guia 406 Tipo Z185W / E3119.....	2.14
Barra de deslize 407 Tipo Z186W / E3172.....	2.14



CASQUILHOS GRAFITADOS BOLEXP



O desenvolvimento de sistemas de guiamento auto-lubrificantes surge da necessidade de resolver problemas relativamente à lubrificação. Estes surgem devido à dificuldade de acesso ou devido à necessidade de contínua e permanente lubrificação, o que o óleo não pode assegurar.

Os postigos de grafite, funcionando como lubrificantes do sólido, permitem manter um excelente nível de lubrificação das placas ou casquilhos durante toda a sua vida útil e estão sempre prontos a utilizar.

Através da sua utilização, o desgaste da estrutura de bronze provoca por si desgaste nos postigos de grafite. O pó de grafite resultante deste ligeiro desgaste será o responsável pela lubrificação de toda a área de contacto.

Os postigos de grafite usados são relativamente pequenos, em comparação com outras marcas, de forma a minimizar a perda de consistência do casquilho de bronze e maximizar a dispersão do lubrificante.

Materiais: Bronze EN1982 CuAl10Fe5Ni5C + grafite

TIPO
Hasco Z1100W
Meusburger E1115

CASQUILHO DE ANEL DE TOPO mod. 311

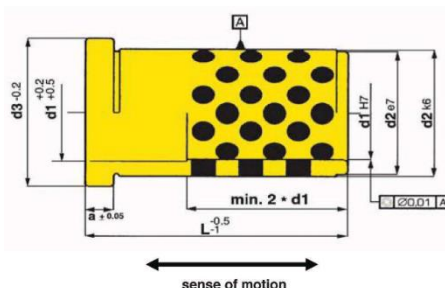

d1	d2	d3	a	L													
				12	17	22	27	36	46	56	66	76	86	96	116	136	
9	14	16	3														
10	14	16	3														
12	18	23	6														
14	20	25	6														
15	20	25	6														
16	22	27	6														
18	26	31	6														
20	26	31	6														
22	30	35	6														
24	30	35	6														
30	42	47	6														
32	42	47	6														
40	54	60	10														
42	54	60	10														

Para pedido indique Casq 311 d1 x L

CASQUILHO DE ANEL mod. 312

TIPO
Hasco Z1000W
Meusburger E1105

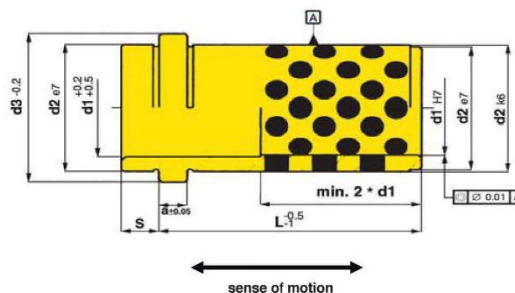

d1	d2	d3	S	a	L													
					17	22	27	36	46	S6	66	76	86	96	116	136	156	196
9	14	16	5	3														
10	14	16	5	3														
14	20	25	6	6														
15	20	25	6	6														
18	26	31	8	6														
20	26	31	8	6														
22	30	35	8	6														
24	30	35	8	6														
30	42	47	8	6														
32	42	47	8	6														
40	54	60	10	10														
42	54	60	10	10														

Para pedido indique Casq 312 d1 x L

TIPO
 Hasco Z13W
 Meusburger E1125

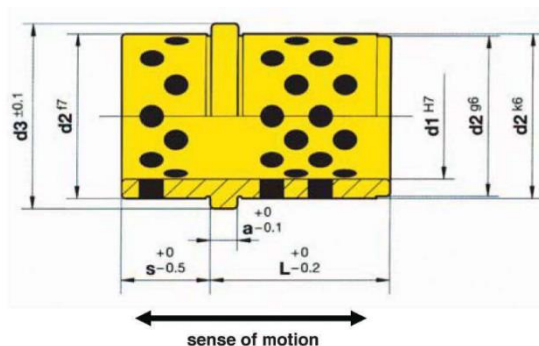
CASQUILHO DE ANEL mod. 313

d1	L	d2	d3	a	S
14	17	20	25	6	9
15	17	20	25	6	9
18	22	26	31	6	17
20	22	26	31	6	17
22	27	30	35	6	22
24	27	30	35	6	22
30	36	42	47	6	27
32	36	42	47	6	27

Para pedido indique **Casq 313 d1 x L**

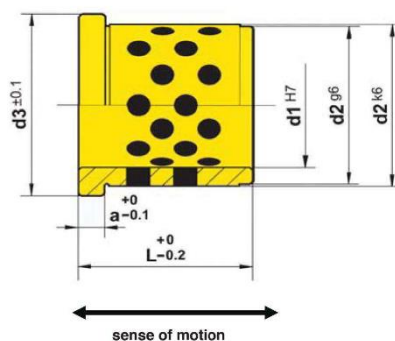
CASQUILHO DE ANEL DE TOPO mod. 401

d1	L	d2	d3	a
20	26	28	32	6
20	35	28	32	6
25	26	32	36	6
25	35	32	36	6
25	45	32	36	6
32	35	40	45	8
32	45	40	45	8
40	45	50	56	8

Para pedido indique **Casq 401 d1 x L**

CASQUILHO DE ANEL mod. 402

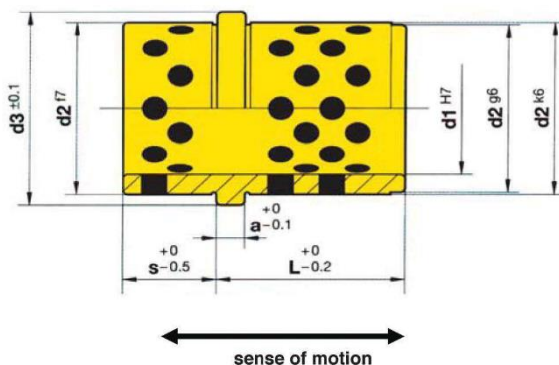

d1	L	d2	d3	a	S
12	22	18	22	6	9
16	22	22	26	6	12
16	26	22	26	6	12
20	26	28	32	6	15
20	35	28	32	6	15
25	26	32	36	6	18
25	35	32	36	6	18
25	45	32	36	6	18
32	35	40	45	8	20
32	45	40	45	8	20
40	45	50	56	8	25
40	63	50	56	8	25

Para pedido indique **Casq 402 d1 x L**

CASQUILHO DE ANEL mod. 403

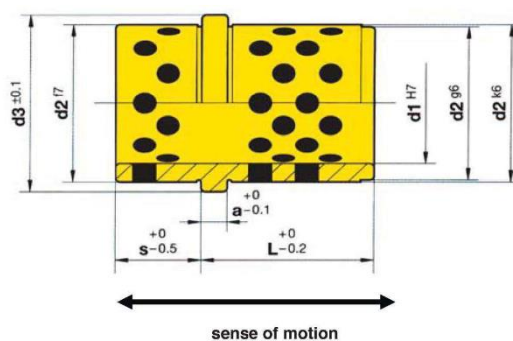

D1	D2	D3	L+S	L	S	a
12	18	22	32	16	16	5
14	20	24	32	16	16	5
16	22	26	32	16	16	5
18	26	30	32	16	16	5
20	28	32	32	16	16	6
25	34	38	32	16	16	7
32	40	45	50	25	25	7
40	48	52	65	33	32	8

Para pedido indique **Casq 403 d1 x L**

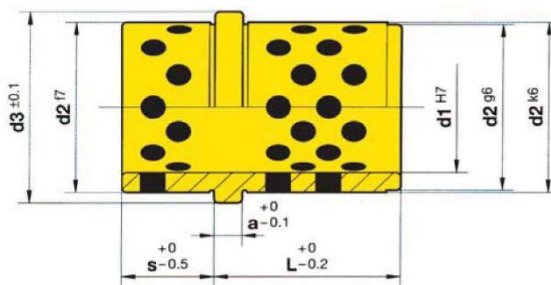
CASQUILHO DE ANEL mod. 404

↔
sense of motion

d1	L	d2	d3	a	S
12	17	16	20	4	8
16	17	20	24	4	12
16	21	20	24	4	12
18	21	25	30	6	17
18	26	25	30	6	17
20	26	30	35	6	17
22	21	30	35	6	17
22	26	30	35	6	17
25	26	35	40	8	18
25	35	35	40	8	18
30	35	40	45	8	21

Para pedido indique Casq 404 d1 x L

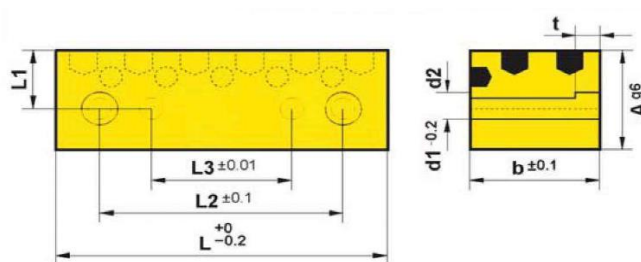
RÉGUA GUIA mod. 405

↔
sense of motion

A	b	L	L1	L2	L3	d1	d2	t
20	15	63	13	47	25	6	7	7
20	15	300						
20	20	63	13	47	25	6	7	7
20	20	80	13	64	40	6	7	7
20	20	100	13	84	60	6	7	7
20	20	300						
25	25	100	16	80	50	8	9	9
25	25	125	16	105	75	8	9	9
25	25	300						
25	30	125	16	105	75	8	9	9
25	30	160	16	140	110	8	9	9
25	30	300						

Para pedido indique Reg 405 A x b x L

TIPO

Hasco Z1850W

Meusburger E3151



RÉGUA GUIA mod. 406

TIPO
Hasco Z185W
Meusburger E3119

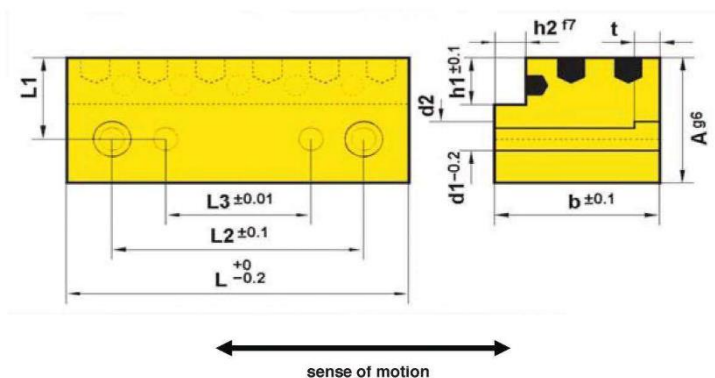

A	b	L	L1	L2	L3	d1	d2	t	h1	h2
20	20	63	13	47	25	6	7	7	6	5
20	25	63	13	47	25	6	7	7	6	5
20	25	80	13	64	40	6	7	7	6	5
20	25	100	13	84	60	6	7	7	6	5
25	31	100	16	80	50	8	9	9	7	6
25	31	125	16	105	75	8	9	9	7	6
25	38	125	16	105	75	8	9	9	7	8
25	38	160	16	140	110	8	9	9	7	8

Para pedido indique Reg 406 A x b x L

BARRA DE DESLIZE mod. 407

TIPO
Hasco Z186W
Meusburger E3172

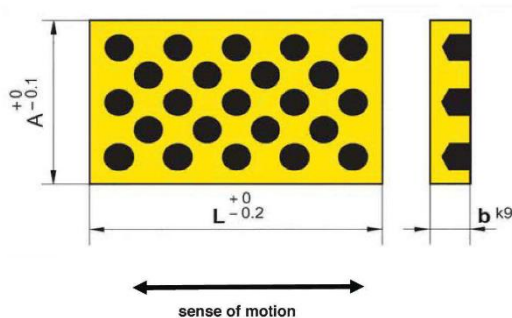

A	L	b
20	63	5
20	300	6
25	63	5
25	80	5
25	300	6
30	80	6
30	100	6
30	300	6
40	80	6
40	100	6
40	125	6
40	300	6

Para pedido indique Barra Deslize 407 A x L x b

CASQUILHOS GRAFITADOS MEM

TIPO

Hasco Z1000W

Meusburger E1115

CASQUILHO DE ANEL mod. MEM 10W

Material: Bronze CuZn25A15Mn4 + Grafite

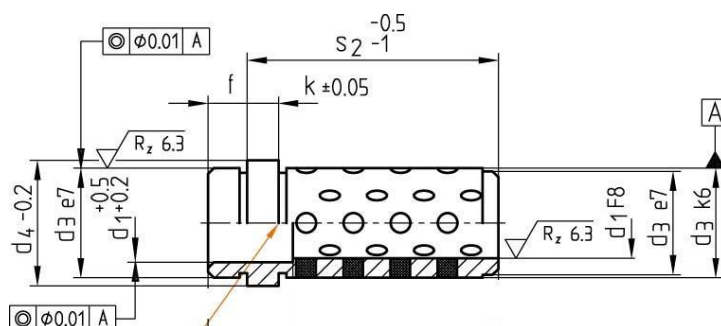



S2	d1	d4	d3	k
12	9	16	14	3
17		16	14	3
22		16	14	3
27		16	14	3
36		16	14	3
46		16	14	3
56		16	14	3
12	10	16	14	3
17		16	14	3
22		16	14	3
27		16	14	3
36		16	14	3
46		16	14	3
56		16	14	3
17	14	25	20	6
22		25	20	6
27		25	20	6
36		25	20	6
46		25	20	6
56		25	20	6
66		25	20	7
76		25	20	9
17		15	25	20
22	25		20	6
27	25		20	6
36	25		20	6
46	25		20	6
56	25		20	6
66	25		20	8
76	25	20	10	
17	18	31	26	6
22		31	26	6
27		31	26	6
36		31	26	6
46		31	26	6
56		31	26	6
66		31	26	6
76	31	26	6	
17	20	31	26	6
22		31	26	6
27		31	26	6
36		31	26	6
46		31	26	6
56		31	26	6
66		31	26	6
76	31	26	6	
22	22	35	30	6
27		35	30	6
36		35	30	6
46		35	30	6
56		35	30	6
66		35	30	6
76		35	30	6
86	35	30	6	

S2	d1	d4	d3	k
96	22	35	30	6
116		35	30	6
22	24	35	30	6
27		35	30	6
36		35	30	6
46		35	30	6
56		35	30	6
66		35	30	6
76		35	30	6
86		35	30	6
96		35	30	6
116		35	30	6
27	30	47	42	6
36		47	42	6
46		47	42	6
56		47	42	6
66		47	42	6
76		47	42	6
86		47	42	6
96		47	42	6
116		47	42	6
136		47	42	6
27	32	47	42	6
36		47	42	6
46		47	42	6
56		47	42	6
66		47	42	6
76		47	42	6
86		47	42	6
96		47	42	6
116		47	42	6
136		47	42	6
46	40	60	54	10
56		60	54	10
66		60	54	10
76		60	54	10
86		60	54	10
96		60	54	10
116		60	54	10
136		60	54	10
156		60	54	10
196		60	54	10
46	42	60	54	10
56		60	54	10
66		60	54	10
76		60	54	10
86		60	54	10
96		60	54	10
116		60	54	10
136		60	54	10
156		60	54	10
196		60	54	10

Para pedido indique Casq Graf MEM 10W/S2 x d1